

APPLICATIONS		REVISIONS			
NEXT ASSEMBLY	USED ON	REV.	DESCRIPTION	DATE	APPROVED
		A	RELEASED TO SALES	2-15-91	AG
		B	UPDATED; ECO 2732	5-2-00	CBV
		C	DELETED NOTE 7; ECO-05633	11-10-06	CBV

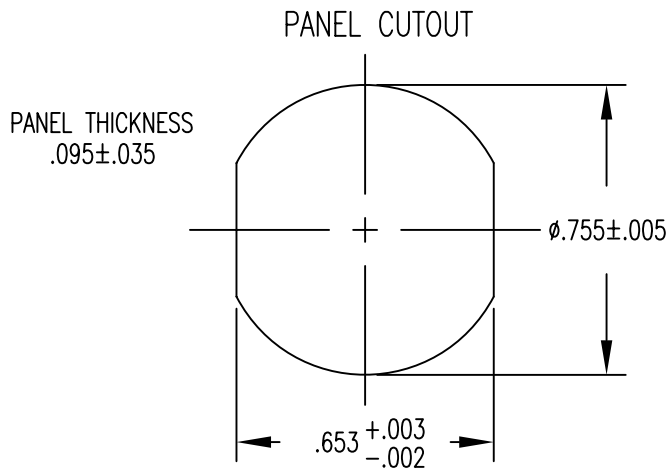
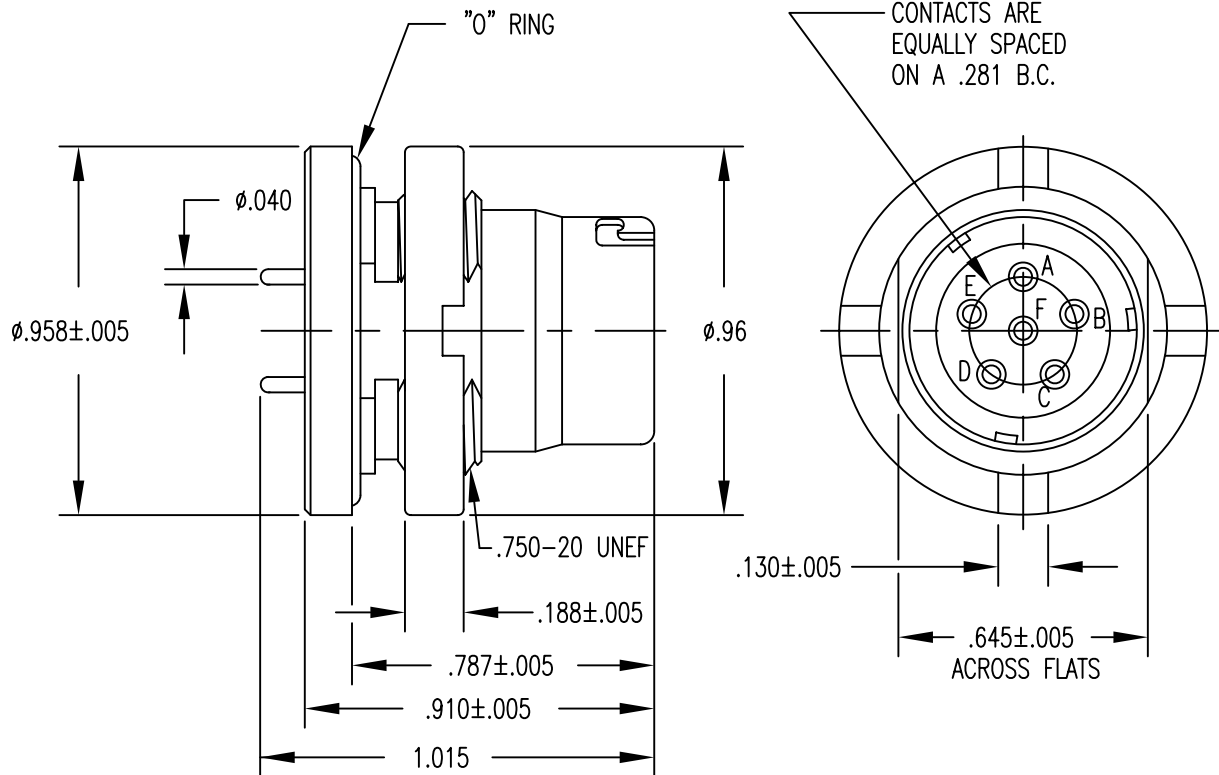

FILE NAME: MC-ON241775-4.dwg

UNLESS OTHERWISE SPECIFIED DIMENSIONS ARE IN INCHES TOLERANCES ARE: FRACTIONS DECIMALS ANGLES $\pm 1/64$.XX $\pm .01$ $\pm 1/2^\circ$.XXX $\pm .003$	CONTRACT NO.		MIL-CON™ AN AFFILIATE OF THE PHOENIX COMPANY OF CHICAGO				
	APPROVALS					DATE	MC-ON241775-4 AUDIO CONNECTOR
THE INFORMATION DISCLOSED IN THIS DOCUMENT IS CONFIDENTIAL AND PROPRIETARY TO MIL-CON, INC. AND MAY NOT BE USED FOR MANUFACTURE OR ANY OTHER PURPOSE WITHOUT THE WRITTEN CONSENT OF MIL-CON, INC.	DRAWN	A. Green	02/15/91	SIZE	FSCM NO.	DWG. NO.	REV.
	CHECKED	A. Huezio	11/13/06	A	63525	SD: MC-ON241775-4	C
	ISSUED			SCALE	NONE	SHEET 1	OF 2

SPECIFICATIONS:

- 1) MATERIALS:
SHELL AND PANEL NUT: STAINLESS STEEL (CLASS 304)
CONTACTS (REAR): COPPER ALLOY
CONTACTS (FRONT): BERYLLIUM COPPER
INSULATOR: DIALLYL PHTHALATE PER MIL-M-14. TYPE MDG
- 2) FINISHES/COLOR:
SHELL AND PANEL NUT: PASSIVATED, SAND BLASTED
CONTACTS (REAR): 0.000030 GOLD PER MIL-G-45204, TYPE II, CLASS 0;
OVER 0.000100 NICKEL PER QQ-N-290
CONTACTS (FRONT): 0.000100 GOLD PER MIL-G-45204, TYPE II, CLASS 1;
OVER 0.000100 NICKEL PER QQ-N-290
INSULATOR: BLUE
- 3) ELECTRICAL PROPERTIES:
OPERATING VOLTAGE: 60 VOLTS MAXIMUM POTENTIAL
CURRENT RATING: 0.5 AMPS MAXIMUM
DIELECTRIC BREAKDOWN: 500 VOLTS RMS
INSULATION RESISTANCE: 1000 MEGOHMS MINIMUM
CONTACT RESISTANCE: 0.040 OHMS MAXIMUM FROM 1 TO 1500 MATINGS
0.100 OHMS MAXIMUM FROM 1500 TO 3000 MATINGS
1.000 OHMS MAXIMUM AFTER 3001 MATINGS
- 4) MECHANICAL PROPERTIES:
AIR PRESSURE: 3.0 P.S.I.
DURABILITY: 3000 CYCLES, MATE AND UNMATE
OPERATING TEMPERATURE: -52°C TO +95°C
WATER IMMERSION: 48 HOURS AT 6 FEET
- 5) MC-ON241775-4 RECEPTACLE MATES WITH:
ON190305 - ALL VERSIONS
ON241774 - ALL VERSIONS
- 6) DIMENSIONS ARE FOR REFERENCE ONLY, UNLESS OTHERWISE SPECIFIED

MIL-CON TM	FILE NAME: MC-ON241775-4.dwg			
	SIZE	FSCM NO.	DWG. NO.	REV.
	A	63525	SD: MC-ON241775-4	C
DRAWN A. Green	SCALE	NONE	SHEET 2	OF 2
ISSUED				